



element
by vinotemp

A PROUD HERITAGE OF EXPERIENCE & QUALITY



DUAL-ZONE WINE COOLER

VT-300SS-2Z (APPROX 300 BOTTLES)

OWNER'S MANUAL



element
by vinotemp

WWW.VINOTEMP.COM



element
by vinotemp

WWW.VINOTEMP.COM

YOUR WINE CELLAR

This unit can be used for storage and/or service. The unit has a glass door and soft interior light that you can use to display your wine.

SERVING WINES

Storing wines at the proper temperature is important. To preserve them as long as possible wine should be stored at approximately 55° Fahrenheit. However, the chart below suggests the optimal drinking temperature for the different styles of wine.

°C	°F	Wine Style
19	66	Armagnac, Brandy, Cognac
18	64	Full Bodied Red Wines, Shiraz
17	62	Tawny Port
15	59	Medium Bodied Red Wines
14	57	Amontillado Sherry
13	55	Light Bodied Red Wines
12	54	Full Bodied White Wines
11	52	Medium Bodied White Wines
10	50	Rosé, Light Bodied White Wines
9	48	Vintage Sparkling
8	46	Fino Sherry
7	45	Non Vintage Sparkling

General Operating Instructions

Remove all external and internal packaging from your appliance. Be sure that all parts have been included before discarding any packaging materials. You may want to keep the box and packing materials for use at a later date.

Upon receipt and inspection of unit, the supply cord must be replaced if it is damaged. Contact our customer service at 1-800-777-8466 or info@vinotemp.com.

Let the unit rest UNPLUGGED for 24 hours once you have it placed in your home.

**READ ALL INSTRUCTIONS BEFORE USING THIS APPLIANCE
-Save these instructions-**

**To register your product, visit:
<http://www.vinotemp.com/Warranty.aspx>
Register your warranty within 10 days of receiving the unit.
Please be sure to retain your proof of purchase.**

Protect Your Investment with an Extended Warranty!



Add a New Leaf extended warranty to your order, and have the security of knowing that if there should be a problem, even years in the future, New Leaf will be there to assist! Usable for any Wine Cellar or other electronic device manufactured by Vinotemp. Add this warranty to purchases made from vinotemp.com or other qualified vendors. Warranty must be registered within the first 10 days from original purchase.

Visit www.Vinotemp.com to purchase.



element
by vinotemp

W W W . V I N O T E M P . C O M

TABLE OF CONTENTS

IMPORTANT SAFETY INSTRUCTIONS	6
ELECTRICAL CONNECTION	7
PARTS AND SPECIFICATIONS	8
INSTALLATION	9
OPERATING YOUR WINE COOLER.....	10
CARE AND MAINTENANCE	12
TROUBLESHOOTING.....	13
TERMS OF SALE AND WARRANTY	14
SERVICE & IMPORTANT NOTICE	16

IMPORTANT SAFETY INSTRUCTIONS



To reduce the risk of fire, electrical shock or injury when using your appliance, follow these basic precautions:

- Do not operate this or any other appliance with a damaged cord.
- Do not operate if housing is removed or damaged.
- Exercise caution and use reasonable supervision when appliance is used near children. Never allow children to operate, play with or crawl inside the appliance. Keep packing materials away from children.
- Before performing any maintenance or cleaning, ensure that the unit is unplugged or that the power line is disconnected.
- Do not clean appliance with flammable fluids. Do not store or use gasoline or other flammable vapors and liquids in the vicinity of this or any other appliance. The fumes can create a fire hazard or explosion.
- Exercise caution when moving and installing the unit. The cooler is heavy and may require two or more people when moving the unit to prevent strain or injury.
- To ensure proper ventilation for your appliance, the front of the unit must be completely unobstructed. Choose a well-ventilated area with temperatures above 60°F and below 90°F.
- Locate the unit away from direct sunlight and sources of heat (stove, heater, radiator, etc). This unit is intended for indoor use only and must be installed in an area protected from the elements.
- Place the appliance on a solid, level surface.
- Do not attempt to repair or replace any part of your appliance unless it is specifically recommended in this manual. All other servicing should be referred to a qualified technician.
- Connect to properly polarized outlets only. It is recommended that a separate circuit, serving only your appliance be provided. Use receptacles that cannot be turned off by a switch or pull chain. Be sure that the plug is fully inserted into the receptacle.
- To protect against electric shock, do not immerse appliance, plug or cord in water or other liquids. Avoid locating the unit in moist areas.
- This appliance is designed to be built-in (fully-recessed) or freestanding.
- Do not use this appliance for other than its intended purpose. For indoor, household use only.
- Do not operate the unit with wet hands, while standing on a wet surface or while standing in water.
- Do not use solvent-based cleaning agents or abrasives on the interior of the cooler. These cleaners may damage or discolor the interior.
- Keep fingers out of pinch point areas and be careful when closing doors if children are around.
- This appliance is designed for storing and cooling wines. Do not store perishable food or medical products within the unit.
- When disposing of refrigerated appliances, special handling is often required. It is the consumer's responsibility to comply with federal and local regulations when disposing of this product.
- Do not slide your wine cooler into place.
- **WARNING:** Risk of child entrapment and suffocation. Before you throw away this or an old unit, take off the door. Leave the shelves in place, so that children may not easily climb inside.

ELECTRICAL CONNECTION



Improper use of the grounded plug can result in the risk of electrical shock. If the power cord is damaged, frayed or shows cracks or abrasions across its length, have it replaced at an authorized service center.

For your protection, this unit is equipped with a 3-conductor cord set that has a molded 3-prong grounding-type plug, and should be used in combination with a properly connected grounding-type outlet.

- Do not under any circumstances cut or remove the third ground prong from the power cord supplied. For personal safety, this appliance must be properly grounded.
- The cord should be secured behind the unit and not left exposed or dangling to prevent accidental injury.
- A standard electrical supply (115V AC only, 60Hz, 15A), properly grounded in accordance with the National Electrical Code and local codes and ordinances, is required.
- Never unplug the unit by pulling the power cord. To disconnect the appliance, always grip the plug firmly and pull straight out from the wall outlet. When moving the unit, be careful not to damage the power cord.
- The unit should always be plugged into its own individual electrical outlet with a voltage rating that matches the rating label on the unit.

Extension Cord

CAUTION: It is strongly recommended that you do not use an adapter or an extension cord with this unit.

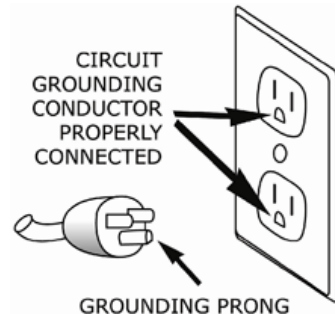

PARTS AND SPECIFICATIONS

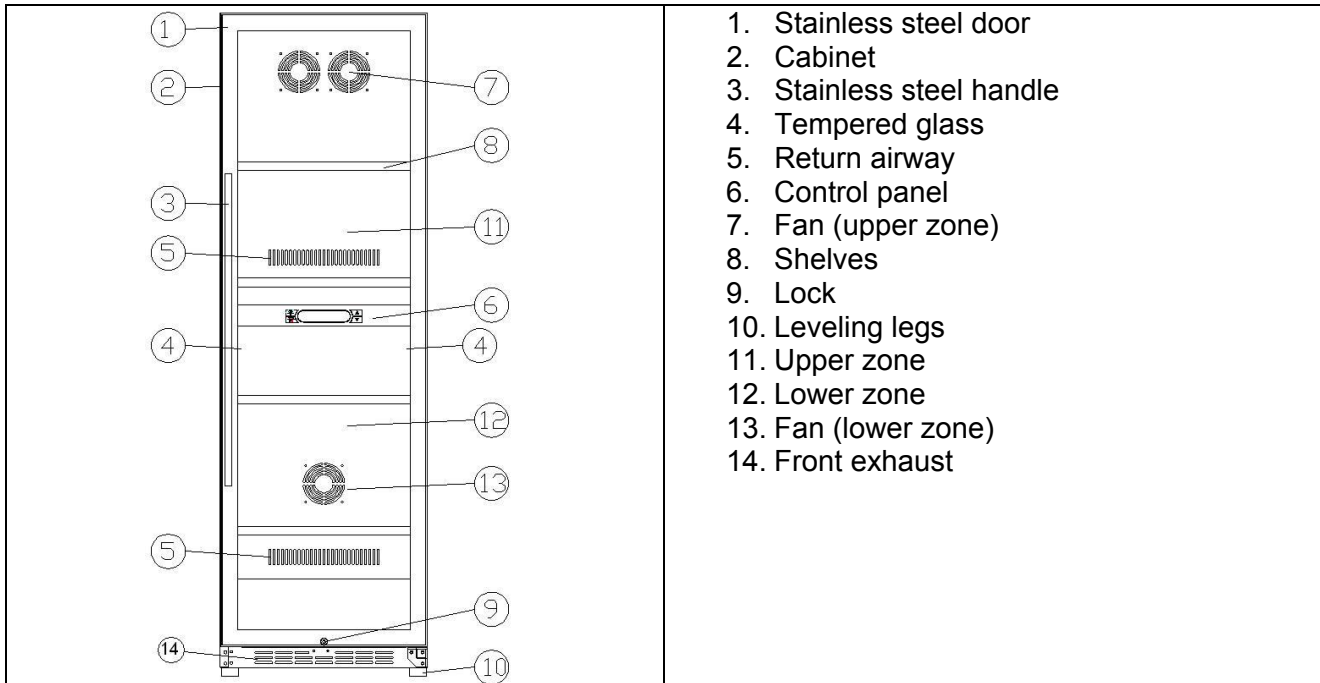

1. Stainless steel door
2. Cabinet
3. Stainless steel handle
4. Tempered glass
5. Return airway
6. Control panel
7. Fan (upper zone)
8. Shelves
9. Lock
10. Leveling legs
11. Upper zone
12. Lower zone
13. Fan (lower zone)
14. Front exhaust

Model No.	VT-300SS-2Z
Voltage	AC 115V
Frequency	60 Hz
Ambient Temperature Range	41° - 100°F / Humidity 45~90%
Control Temperature Range	Upper Zone (40° - 56°F) / Lower Zone (54° - 65°F)
Refrigerant	R600a/4.94 oz.
Power Consumption	1.39 kWh/24h
Input Power	190W / 2A
Volume	21.2 cu. ft
Net Weight	282 lbs
Gross Weight	298 lbs
Dimensions (W x D x H)	29.5 in x 27.1 in x 74 in
Box Dimensions (W x D x H)	30.9 in x 29.1 in x 75.6 in

*Note: VT-300SS-2Z bottle storage capacity is based on a standard 750 ml wine bottle. Storing large and/or oddly shaped bottles (including champagne and sparkling wine bottles) will decrease the bottle capacity of the wine cooler.



element
by vinotemp

WWW.VINOTEMP.COM

INSTALLATION

- Remove all packing material before using your wine cooler.
- **IMPORTANT:** Before connecting the unit to a power source, let it stand upright for approximately 24 hours. This will reduce the possibility of a malfunction in the cooling system from handling during transportation.
- Clean the interior surface with lukewarm water and a soft cloth.
- This unit is designed for freestanding or built in installation but indoor use only. Position the unit in a dry and well-ventilated place. Avoid placing the wine cooler near any source of heat or moisture, or in direct sunlight. Do NOT install the unit in a location with an ambient temperature that will fall below 60°F.
- For built-in installation, leave a ¼" (6.35mm) space on each side and at the top of the wine cooler to ensure proper air circulation to cool the compressor and condenser. Also, be sure to not obstruct the front exhaust vent with any objects as this may affect the unit from performing properly.
- For freestanding installation, 6" of space at the back, 10-12" of space on each side, and unlimited clearance at the top of the wine cooler are suggested to ensure proper air circulation to cool the compressor and condenser. Do not place underneath a table, counter top, or anything of the sort as this will not allow for proper air circulation.
- Do not slide the unit into place.
- Place the wine cooler on a level surface strong enough to support it when it is fully loaded. To level the wine cooler, adjust the front leveling legs at the bottom of the wine cooler.
- For best performance it is recommended that you install the appliance in a location with an ambient temperature between 41°-100°F. If the ambient temperature is above or below recommended temperatures, the performance of the unit may be affected.
- Plug the wine cooler into an exclusive, properly installed-grounded wall outlet.

INSTALLING THE STAINLESS STEEL HANDLE

This wine cellar includes a stainless steel handle that is not required to operate this unit. To install the handle please follow the below instructions:



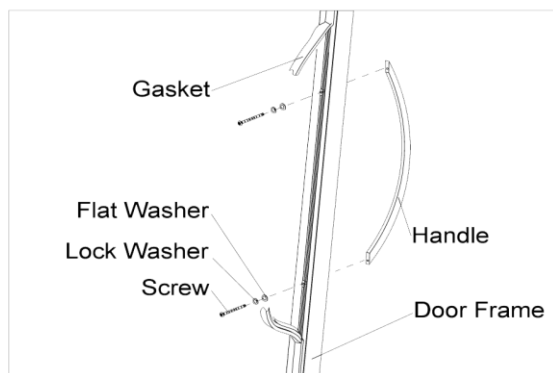





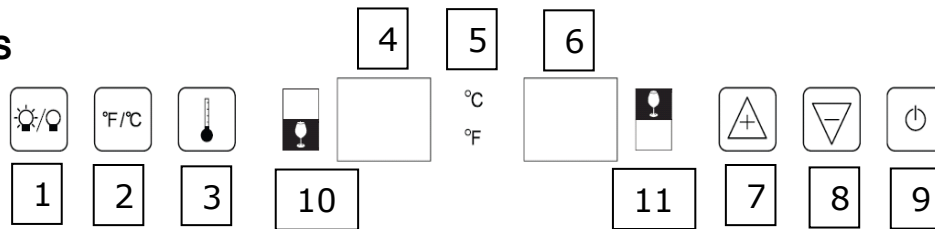

- Pull away the door gasket in the area where the handle is to be installed - you can see two designated holes for handle installation. The gasket is easily displaced by hand, no tools are necessary.
- Install the handle tightly as shown below with the two screws, lock washers and flat washers provided. (DO NOT over tighten as this will cause damage to the handle assembly and stainless steel surface of glass door).
- Replace the door gasket to its original position.



OPERATING YOUR WINE COOLER

CONTROLS



-  Light: turn the inner light ON or OFF.
-  °F/°C Selector: choose to display temperature setting in Fahrenheit or Celsius.
-  To view the set temperature at any time, please press the  button. The set temperature will temporarily flash in the LED display for 5 seconds.
- Temperature display for the lower zone: the LED display will flash when setting the temperature. When not setting the temperature (normal mode), this display will show the current temperature for the lower zone.
- Celsius or Fahrenheit: these lights indicate if the temperature is being shown in Celsius or Fahrenheit.
- Temperature display for the upper zone: the LED display will flash when setting the temperature. When not setting the temperature (normal mode), this display will show the current temperature for the upper zone.
-  UP: use this button to raise the temperature in 1 degree increments.
-  DOWN: use this button to lower the temperature in 1 degree increments.
-  Power: use this button to turn the wine cooler ON or OFF. To power OFF the cooler, press  for a minimum of 5 seconds. Press the same button to power ON. The LED display will show the original temperature set prior to resetting the appliance.
-  Press this symbol to adjust the temperature for the lower zone.
-  Press this symbol to adjust the temperature for the upper zone.

TEMPERATURE ZONES

The wine cooler has two temperature zones. The recommended temperature setting for each zone is:

- Upper zone between 40°-56°F / 5°-13°C (Ideal for sparkling and white wines)
- Lower zone between 54°-65°F / 12°-18°C (Ideal for red and white wines)

If you set the upper zone under 5°C (41°F), the lower zone could be set at 12°C (54°F).

If you set the upper zone under 7-8°C (45°F), the lower zone could be set at 12-13°C (55°F) also.

But if you set the upper zone under 12°C (53°F), the lower zone could be set under 17°C (63°F).







NOTE: The temperature set for the Lower Zone must always be the same or higher than the temperature set for the Upper Zone. For optimal performance, the set temperature of the two zones should differ by at least 10°F.



element
by vinotemp

WWW.VINOTEMP.COM

SETTING A TEMPERATURE

- Choose between Celsius and Fahrenheit by pushing the  button. The temperature will now display in Celsius or Fahrenheit.
- If setting the temperature, press the  button first. You can then select the UP  or DOWN  buttons to change the temperature in one degree increments. When pushing either button for the first time, the readout will show the original temperature set (preset factory setting for UPPER ZONE is 10°C / 50°F and for LOWER ZONE is 16°C / 60°F).
- Pressing the UP  button will increase the temperature by 1 degree.
- Pressing the DOWN  button will decrease the temperature by 1 degree.

NOTE: When using the unit for the first time or after a long period of inactivity, there may be a variance of a few degrees between the selected temperature and the temperature indicated on the LED readout. This is normal due to the length of inactivity, and will correct itself after the unit has run for a few hours. If the unit is unplugged, has lost power or is turned off, wait 3 to 5 minutes before restarting the unit. The unit will not restart before this time delay.

STORING WINE

Note: Bottle capacities are approximate maximums when storing traditional Bordeaux 750 ML bottles and may include bulk storage. Many bottles differ in size and dimensions. As such, the actual number of bottles you may be able to store may vary.

- When adding a bottle to the wine cooler, make sure there is no contact with the back interior of the cooler.
- Ensure that no bottles are placed directly onto the electronic board of the control panel. Always place bottles on the shelves only.
- To avoid damage to the shelves and ensure the cooler maintains a consistent temperature, do not overfill the wine cooler.

SHELVES

To avoid damaging the door gasket, ensure that the door is fully opened when pulling the shelves out of the rail compartment.

- The pull-out shelves allow bottles of wine to be viewed and removed more easily.
- For easy access to the storage bottles, you must pull the shelf approximately $\frac{1}{3}$ out of the rail compartment. This unit was designed with a plastic post on each sides of the shelf track to prevent bottles from falling.
- This unit's shelves may be adjusted to a range of heights.

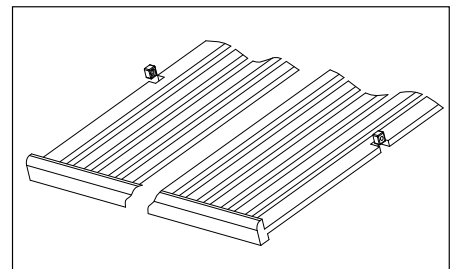

DOOR LOCK

The wine cooler comes with a lock and key combination. The keys are located inside the plastic bag containing the Owner's Manual. To unlock the door, insert the key into the lock and turn it counter-clockwise. To lock the door, insert the key and turn it clockwise, ensuring that the metal pin is fully engaged.

DEFROSTING

The wine cooler defrosts automatically. The evaporator behind the rear wall of the unit automatically defrosts and the condensate collects in the drainage channel behind the rear wall of the unit, and flows through the drainage hole into the drip tray by the compressor, where it evaporates.

CARE AND MAINTENANCE

CLEANING YOUR WINE COOLER

IMPORTANT: Always unplug the unit before cleaning or performing maintenance. Never use harsh cleansers or scouring pads to clean any part of the unit.

- Turn off the power, unplug the appliance, and remove all items including shelves.
- Wash the inside surfaces with a warm water and baking soda solution. The solution should be about 2 tablespoons of baking soda to a quart of water.
- Wash the shelves with a mild detergent solution.
- Wring excess water out of the sponge or cloth before cleaning control panels or any electrical parts.
- Wash the outside cabinet with warm water and mild liquid detergent. Rinse well and wipe dry with a clean soft cloth.

POWER FAILURE

Most power failures are corrected within a few hours and should not affect the temperature of your appliance. If the power is off for an extended period of time, proper steps should be taken to protect your contents.

INACTIVITY

If the unit will not be used for a period of less than three weeks, leave the cooler operating. If the period of inactivity is several months, remove all items and turn the unit off. Clean and dry the interior thoroughly. Leave the door open slightly to prevent any possible moisture build-up.

MOVING YOUR WINE COOLER

Before moving your wine cooler, first be sure to remove all items from the cooler.

- Securely tape down any loose items, such as shelves, inside the unit.
- Turn the adjustable leg up to the base to avoid damage.
- Tape the door shut.
- Ensure that the unit stays securely in the upright position during transportation. Protect the outside of the appliance with a blanket or similar item.

ENERGY SAVING TIPS

- The unit should be located in the coolest area of the room away from heat sources or direct sunlight.
- Ensure that the unit has proper allowances on all sides for proper ventilation. Never cover any air vents.
- Only open the cooler door for as long as necessary. Frequent opening of the door will affect internal temperature.



PROBLEMS WITH YOUR WINE COOLER

Most common problems can be solved easily, saving you the cost of a possible service call. Try the following suggestions to see if you can solve the problem before contacting Vinotemp at Info@Vinotemp.com.

TROUBLESHOOTING

PROBLEM	POSSIBLE CAUSE
Wine Cooler does not operate	<ul style="list-style-type: none"> • Ensure unit is plugged into an electrical outlet. • Check if unit is turned off. • Check for a tripped circuit breaker or blown fuse.
Wine Cooler is not cold enough	<ul style="list-style-type: none"> • Check the temperature control setting. • External environment or ambient temperature may require a higher setting. • Check if door does not close completely or is open too often. • Check if door gasket does not seal properly.
Wine Cooler turns on and off frequently	<ul style="list-style-type: none"> • The room temperature may be hotter than normal. • Check if door does not close completely or is open too often. • Check if door gasket does not seal properly. • The temperature control is not set correctly.
Wine Cooler light does not work	<ul style="list-style-type: none"> • Ensure unit is properly plugged in. • Check for a tripped circuit breaker or blown fuse. • Check if the light switch is OFF.
Wine Cooler makes too much noise or vibrates	<ul style="list-style-type: none"> • Check to ensure the unit is level. • The rattling noise may come from the flow of refrigerant. This is normal. • As each cycle ends, you may hear gurgling sounds caused by the flow of refrigerant in the unit. This is normal. • Contraction and expansion of the inside walls may cause popping and crackling noises.
Wine Cooler door will not close properly	<ul style="list-style-type: none"> • Check to ensure the unit is level. • The door was reversed and was not properly installed. • The gasket is dirty. • The shelves are out of position.
Wine Cooler zone is not functioning	<ul style="list-style-type: none"> • Check the cooling fan near the condenser, make sure its moving. • Check the cooling fan in the middle board, make sure its moving. • Check the cooling gas, it may have a leak (if both zones are failing).

TERMS OF SALE AND WARRANTY

Vinotemp International Corp. ("Seller") and the person or entity that acquires these goods from Seller ("Purchaser") hereby fully agrees to the following terms and conditions of the sale: Shipping fees are the responsibility of the Purchaser whether freight prepaid or freight collect. Seller assumes no responsibility for the goods sold to the Purchaser once the goods have left the Seller's premises, including, but not limited to, late delivery by the carrier, or for events caused by any difficulty carrier incurs in attempting to fit the goods into the Purchaser's designated location due to the size of the goods or any other reason. Purchaser assumes all responsibility for delivery, payment of freight, access, measurement, installation, hook-up, wiring, moving and storage of the goods. The transportation of all goods is subject to the terms and conditions which the carrier imposes on Purchaser including, but not limited to, additional charges imposed per flight of stairs, and/or additional charges resulting from the carrier's inability to safely and/or adequately use the building elevator to lift the goods. Any claim for damages incurred during shipment by the carrier of the goods are insured and handled directly with the carrier and must be noted at time of delivery. Any damages due to manufacture defects will be handled directly with Seller, subject to the Limited Warranty, below. If the item is damaged by the freight company, Purchaser may cancel the order only by paying for freight costs both ways and a 35% restocking fee.

All sales are final, and unless authorized in writing by the Seller, Purchaser may not return the goods, under any circumstance. If Purchaser refuses to accept the goods, under any circumstance, the Purchaser is liable for the return and cost of freight both ways, and if Seller mutually agrees in writing to take back stocked goods, there will be a restocking/service fee that is 35% of the purchase price of the goods (product must be returned within 30 days, new, unused, and in original packaging). If Purchaser returns goods claiming that the goods are defective and goods are found to be in working condition by the Seller, Purchaser is liable for the return and cost of freight both ways plus an a restocking/service fee that is 35% of the purchase price of the goods. Built-to-Order products (including Cabinets, Racking, and Accessories) are non-returnable. Purchaser must notify Seller of non-conforming goods within four days of delivery, after which time all goods are deemed accepted. If an order has been placed and production has started, cancellation of your order will be a 15% charge. If Purchaser tenders payment with a check that has insufficient funds (NSF), or stops payment on a check or credit card for any reason, Purchaser agrees to pay for all costs associated with the Seller's collection or litigation of such a claim, including without limitation general and special damages, court costs and attorneys' fees. Finance charges begin the date of invoice. Collection fees plus NSF fee of \$50 will be added to your invoice, which you agree to promptly pay. Title to the goods does not pass until payment is received in full by Seller and Seller retains a security interest in the goods until they are paid for in full, however, from deliver, Purchaser will insure the goods and for any damages caused by the goods (eighteen percent (18%) annual rate). Purchaser assumes and must immediately pay any "credit card arbitration" fees which the credit card companies charge during a dispute. Any disputes not resolved within 30 days from the invoice date will be reported to credit reporting agencies.

LIMITED WARRANTY: Seller warrants that the goods will be free of defects in materials and workmanship as follows:

Furniture style (wood) wine cabinets made in the U.S.: all cooling unit parts for a period of 5 (five) years; cabinetry and labor (uninstalled) for a period of 12 (twelve) months.

Metal cabinet wine units: parts and labor for cooling system and cabinetry for a period of 12 (twelve) months.

For Designer Series units: parts and labor for a period of 12 (twelve) months from date of sale, compressor parts 5 years.

Thermoelectric Units: 90 (ninety) days (including Wine Coolers, Beer Dispensers, Humidor, Portofino Wood Cellars, and Refrigerators).

Wine-Mate Split and Ducted Systems and other installed products and parts only for 1 year, no labor. Other Wine-Mate Cooling Systems are 5 years parts, 1 year labor.

Wine Accessories, Racking Systems and Other items are not warranted. There is no warranty on parts purchased separately. If a purchaser claims a product is "defective", they must obtain a letter from a qualified refrigeration technician at the customers cost, to verify that the unit was installed properly, with proper ventilation and the unit is truly malfunctioning due to manufacture defect. Removal or re-installation of unit is not included in warranted costs. Purchaser's exclusive remedy is limited, at Seller's option; to repair or replace defective part[s] with either new or reconditioned part[s]. Purchaser is responsible for shipping the unit pre-paid to designated facility and Seller will pay return shipping charges in the continental United States for items repaired under warranty within 12 (twelve) months from date of sale. Since the natural variation in texture, density, grain, color, tone and shade of wood is unavoidable; Seller does not guarantee the texture, color, tone or shade of the wood: nor does seller guarantee the colorfastness of wood or against peeling, chipping, cracking or scratching. Note: Unfinished wood is subject to warping; all wood surfaces must be sealed before placing cellar into service. Improper repair or placement of the unit will void the warranty. Any third party repair facility must be pre-approved in writing by Seller, before providing replacement parts under warranty.

IL Romanzo units: Warranty 90 (ninety) days. Replacement part 12 (twelve) months from the date of sale.

Non-New Units (Scratch & Dent/Refurbished/Floor Models), warranty for compressor units is 90 days from your dated invoice and 30 days for thermoelectric units (parts for function only, not cosmetic defects). These units are refurbished and sold as is; Purchaser assumes risks to the quality and performance of goods and assumes the costs of all necessary service or repair not covered herein.

Element Grills (via Element Products LLC), grills have a 1 year parts warranty and a thirty day limited parts warranty on grill accessories.

Warranty period is from the date of sale (not from shipping, delivery, nor installation).

Storage Fees: When having an item serviced by a Vinotemp service technician at the Vinotemp warehouse, Purchaser agrees to pick up their repaired item or make arrangements for return shipping within a 90-day period once they have been notified by Vinotemp through phone call, email, or letter that their unit is ready for pick up. If the item remains in the Vinotemp warehouse after 90 days but no longer than 120 days, the Purchaser will incur additional storage fees. After 120 days in storage, the item will become property of Vinotemp.

All completed cabinetry, racking, or other custom work must be picked up or shipped within a period of 14 days after Vinotemp has notified the Purchaser by phone call, email, or letter. Any completed cabinetry, racking, or other custom work stored longer than 14 days will incur an additional storage fee. After 120 days, the product will become property of Vinotemp.



element
by vinotemp

WWW.VINOTEMP.COM

This Limited Warranty does not cover damage due to such things as accident, misuse, abuse, mishandling, neglect, acts of God, fires, earthquakes, floods, high winds, government, war, riot or labor trouble, strikes, lockouts, delay of carrier, unauthorized repair, or any other cause beyond the control of the Seller, whether similar or dissimilar to the foregoing. Seller is not responsible for any damages caused to Purchaser's property resulting from the goods. This limited warranty applies only inside the Continental US (Alaska, Puerto Rico, Hawaii and other territories/countries are not warranted).

Purchaser understands and acknowledges that the goods sold here are wine cellars, cigar humidors, and/or other similar units which house wine or cigars or other items. Purchaser assumes all risk of using these units, including risk of spoilage, humidity variations, temperature variations, leaks, fire, water damage, mold, mildew, dryness and similar and any other perils that might occur.

Seller is not responsible for incidental or consequential damages, and there are no warranties, expressed or implied, which extend beyond the Limited Warranty described above. Warranty and liability are non-transferable. The implied warranties of merchantability and of fitness for a particular purpose are hereby expressly disclaimed. Some states do not allow the exclusion of incidental or consequential damages, or a waiver of the implied warranties of fitness and/or merchantability, so the above limitations may not apply to you. This warranty gives you specific legal rights and you may also have other rights which vary from state to state. Seller disclaims any indemnification for claims of infringement of any intellectual property of protectable nature. In the event of any dispute between Seller and Purchaser arising out of or relating to these terms and conditions or to the goods sold generally, Purchaser must first file a written claim with Seller within ten days of the occurrence giving rise to the claim and wait an additional thirty days for a response before initiating any legal action. The sale and all terms are subject to California law. Any legal proceeding arising out of or relating to these terms and conditions or to the goods sold Purchaser shall bring, solely and exclusively in the County of Los Angeles. In no event may Purchaser initiate any legal proceeding more than six months after the occurrence of the event giving rise to the dispute. Seller may make non-payment claims until debt is paid in full.

White Glove Delivery: White glove delivery is defined as follows: Delivery will be to the 1st floor only, easy access and NO STAIRS, Doors aligned, feet attached (if necessary) and removal of packaging. Customer agrees that any additional request will result in additional charges.

Note: White Glove Service is only for products weighing over 300lbs.

The above terms and conditions are the only ones governing this transaction and Seller makes no oral representations of any kind. These Terms and Conditions can only be modified in writing, signed by both Purchaser and Seller.



element
by vinotemp

WWW.VINOTEMP.COM

SERVICE & IMPORTANT NOTICE

Upon receipt and inspection of unit, the supply cord must be replaced if it is damaged. Contact our customer service at 1-800-777-8466 or info@vinotemp.com.

The manufacturer has a policy of continuous improvement on its products and reserves the right to change materials and specifications without notice.

WARNING:

**Please do not place the unit within reach of children.
For adult use only.**

Contact **info@vinotemp.com** with any questions or visit
www.vinotemp.com



732 S. Racetrack Road
Henderson, NV 89015
www.vinotemp.com

Vinotemp is a registered trademark of Vinotemp International. All products, features, and services are subject to change without notice. We cannot guarantee the accuracy of the contents of this document. We disclaim liability for errors, omissions, or future changes.

© 2019 Vinotemp International. All rights reserved.

ADJUST SHELVES

Adjust the shelves as shown to fit approximately **300 bottles** in your cooler.

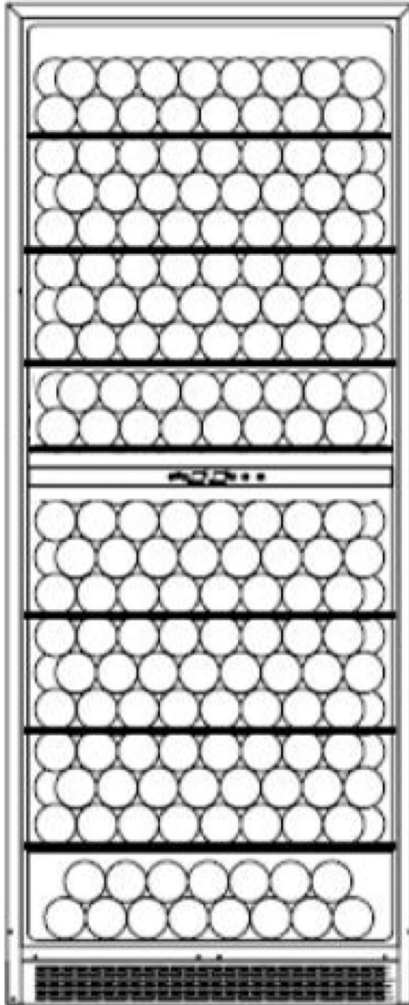

BOTTLE CAPACITY

You may adjust the shelves of your wine cooler to accommodate more or less bottles. If stacking bottles 2-3 high, please do not pull out the shelves.

ADJUST SHELVES

Adjust the shelves as shown to fit approximately **255 bottles** in your cooler.

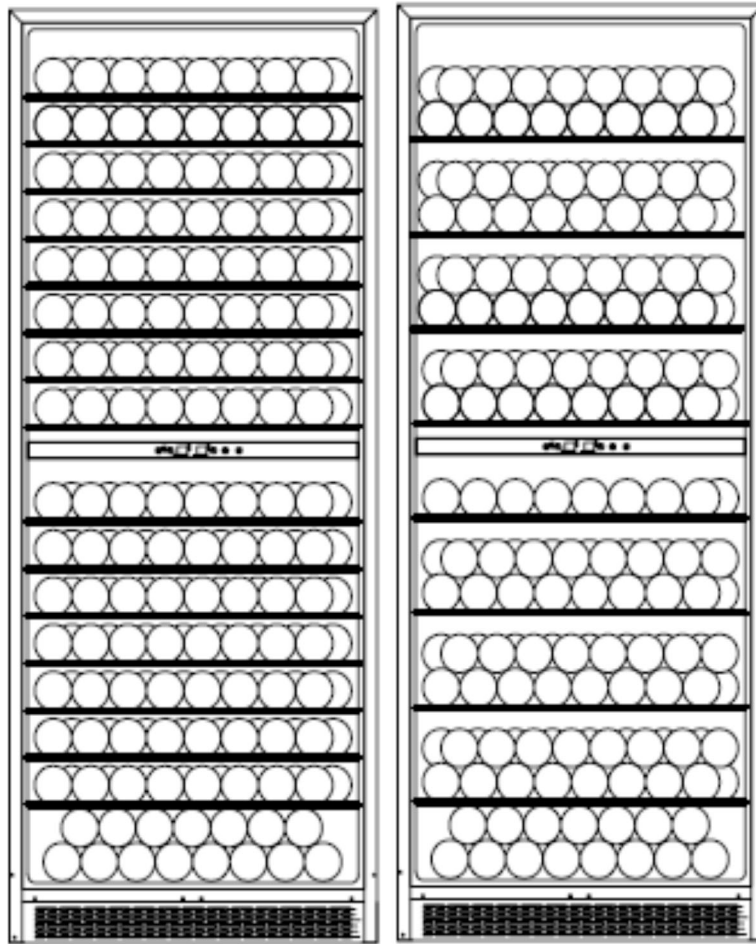

BOTTLE CAPACITY

You may adjust the shelves of your wine cooler to accommodate more or less bottles. If stacking bottles 2-3 high, please do not pull out the shelves.



VT-300SS-2Z SHELF INSTALLATION INSTRUCTIONS

IMPORTANT: PLEASE FOLLOW THESE INSTRUCTIONS PRIOR TO FILLING YOUR COOLER WITH WINE.

1. Insert a shelf at the desired level and gently push it until it reaches the rear of the cabinet.

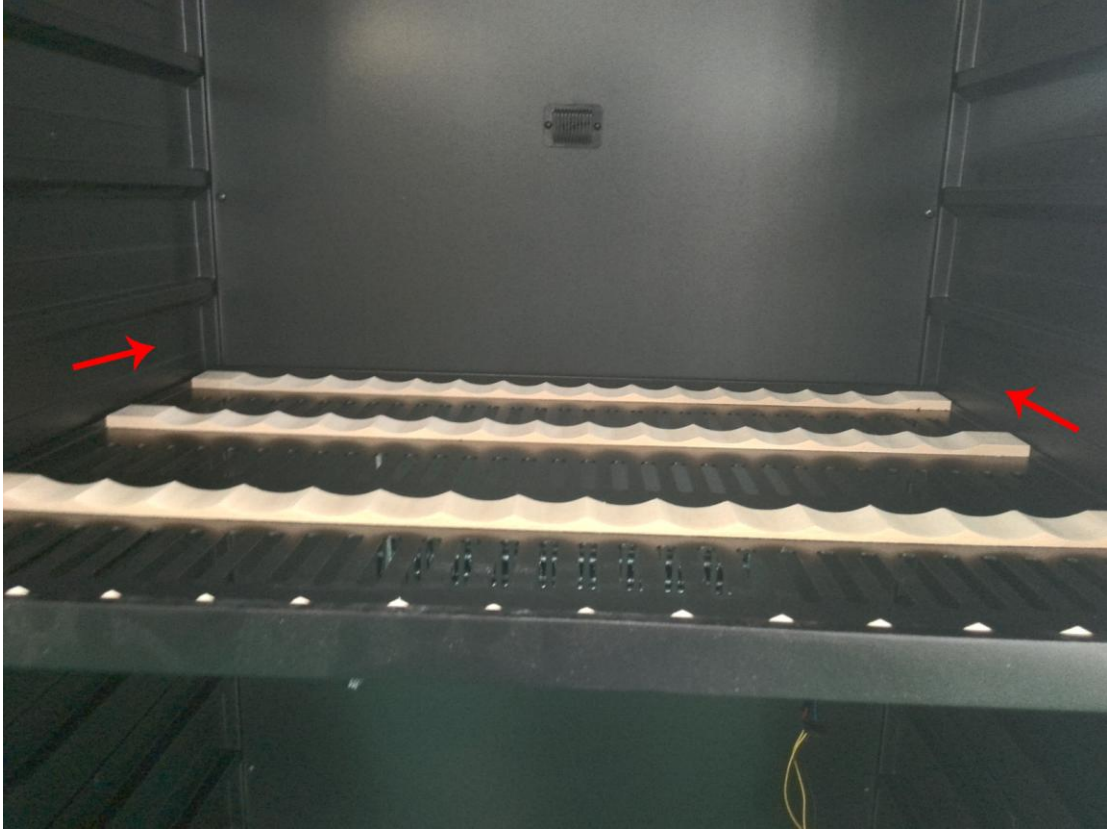

2. Assemble the provided screw and stopper as shown.

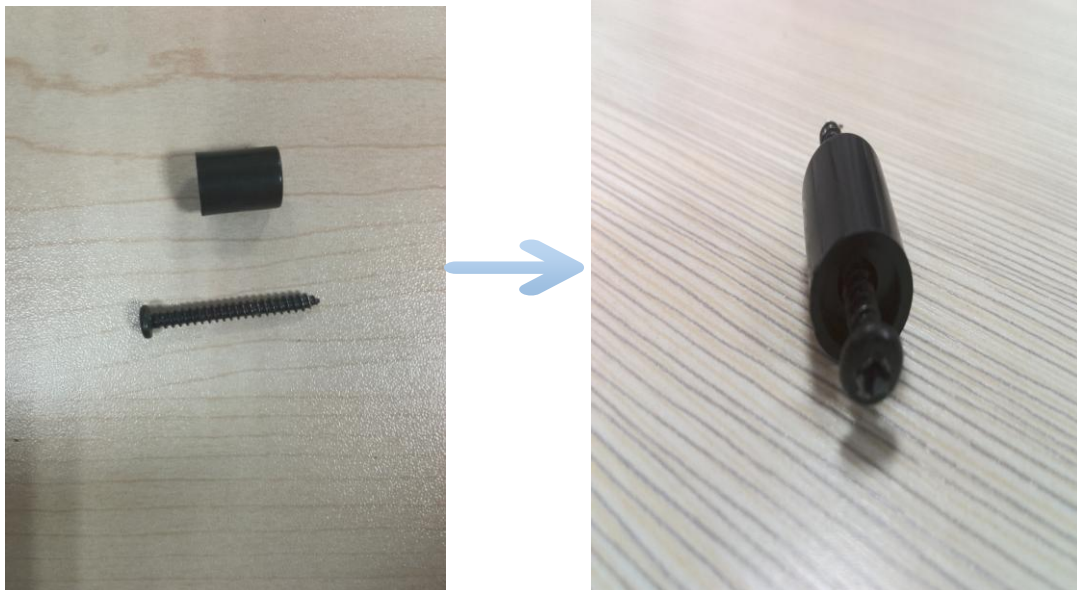

3. Towards the center right and left, just above the shelf, you will see holes on the interior of the cabinet. Insert the assembled screw and stopper into these holes and secure using a Philips head screwdriver.

QUESTIONS? PLEASE CALL 1-800-777-8466 OR EMAIL INFO@VINOTEMP.COM.

Vinotemp.



LEFT



RIGHT



4. Before loading the shelf with wine, check to ensure that each stopper and screw is attached securely. You should not be able to pull the shelf out past the stopper. This will prevent the shelf from falling forward when filled with wine bottles.

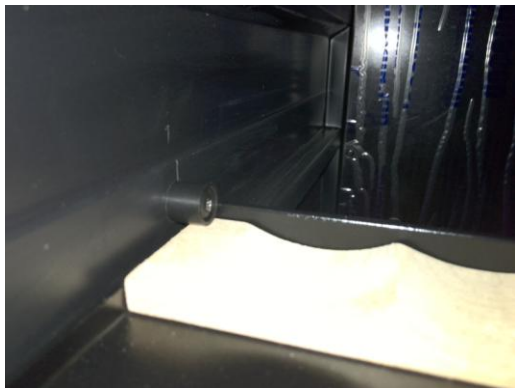

QUESTIONS? PLEASE CALL 1-800-777-8466 OR EMAIL INFO@VINOTEMP.COM.