



WINE RACK ASSEMBLY & INSTALLATION INSTRUCTIONS

A. Preparing for the installation.

The first thing that should be done is to inspect the racks for any type of damage that might have happened during shipping. If there is any damage to the racks please report it right away. Next you should make sure that you have the correct number of racks.

NOTE: The racks have been marked with a letter that corresponds to the drawings. Special care should be taken to keep all pieces with their perspective racks.

Now that you have familiarized yourself with the racks you should think about the best order to assemble and place the racks into the room. Although there is no hard rule for this it is usually best if you start from the back wall and work your way to the front.

B. Assembling Your New Wine Racks

Wine racks come in all shapes, sizes and styles. In the next few sections we will discuss the assembly of some of the most common racks to help you with your installation.

B.1 Regular Racks

Regular racks and many other racks are shipped partially assembled for your convenience. The partially assembled sections are referred to as ladders. Below are the two main types of ladders used.

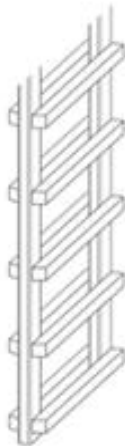

DOUBLE SIDED LADDER

This is the most common type of ladder. The dimensions between the ladders are determined by the size of the cubicles that you ordered.

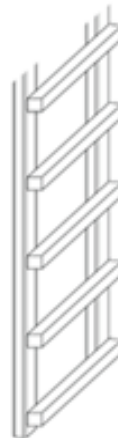

SINGLE SIDED LADDER

This is usually the left or right side of rack

When assembling standard racking it is usually best to sort out the ladders and place them on the ground with the front of the racks facing down.

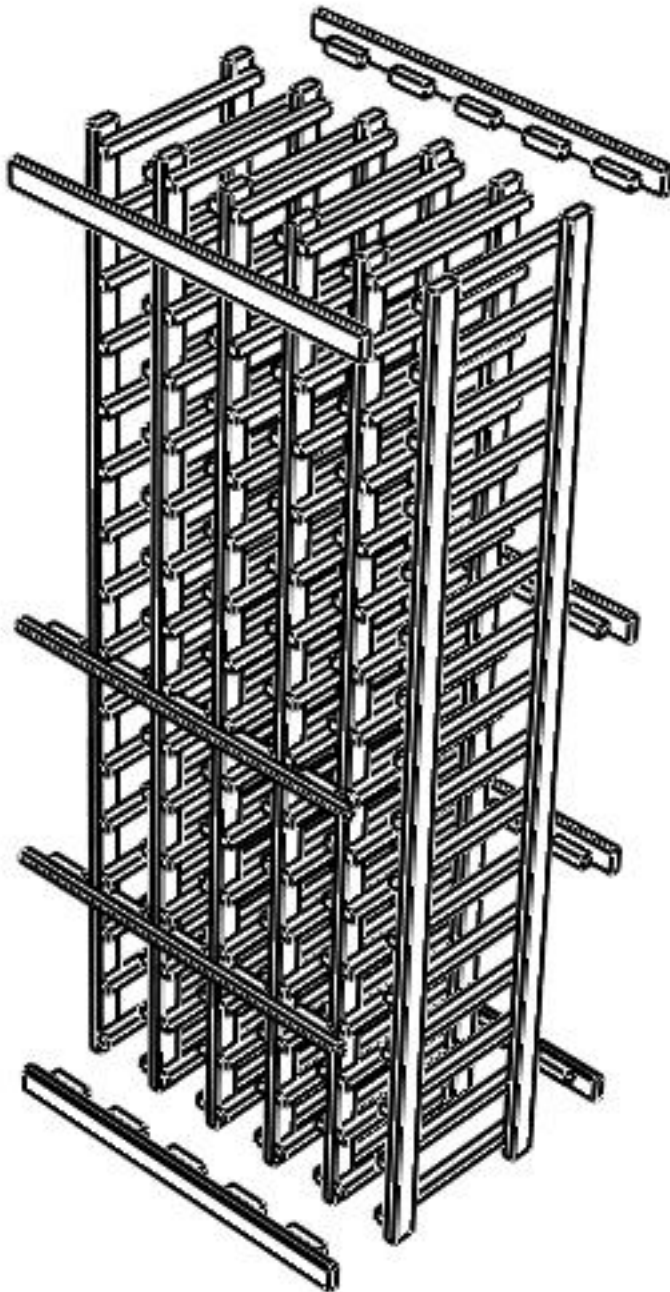

Step 1: Place back Stabilizers onto the ladders. Starting with the top and bottom is recommended then continue with the remainder.

Step 2: Once the back Stabilizers are attached then continue to the front of the rack. The front spacers will generally come in two different heights. The taller spacer will usually go on top and bottom of the front of the rack. The smaller spacers should be placed at the same height as the bottle supports. If your racks have bottle displays then please see that section before attaching spacers.

Front spacers can be put on several different ways. Gluing and screwing are two ways but the most common are stapling or using finishing nails.

Note: Glue, Staples, finishing nails and wood Putty are not included.



Step 3: Wall mounting your racks for safety. Most racks can stand freely on the ground but for safety we always recommend that you anchor the racks to the wall. The back upper stabilizer is a perfect way to do this, just screw or nail the stabilizer to the wall. Another way is to mount angle brackets on top of the rack and to the wall.

B.2 Table Top Wine Racks (Island Racks)

Basically a table top rack is just a standard rack with a top on it. To assemble this type of rack see section B.1 Regular racks this will instruct you on putting together the main part of the rack. After assembling the rack then place the table top on top of the regular racking. Mounting the top to the short rack is not required but is recommended. Finishing nails, staples or screws are often used to attach the top to the racking.

Note: If you have an island rack with other features in it such as diamond bins or case bins then please see their assembly instructions to help you create your island.

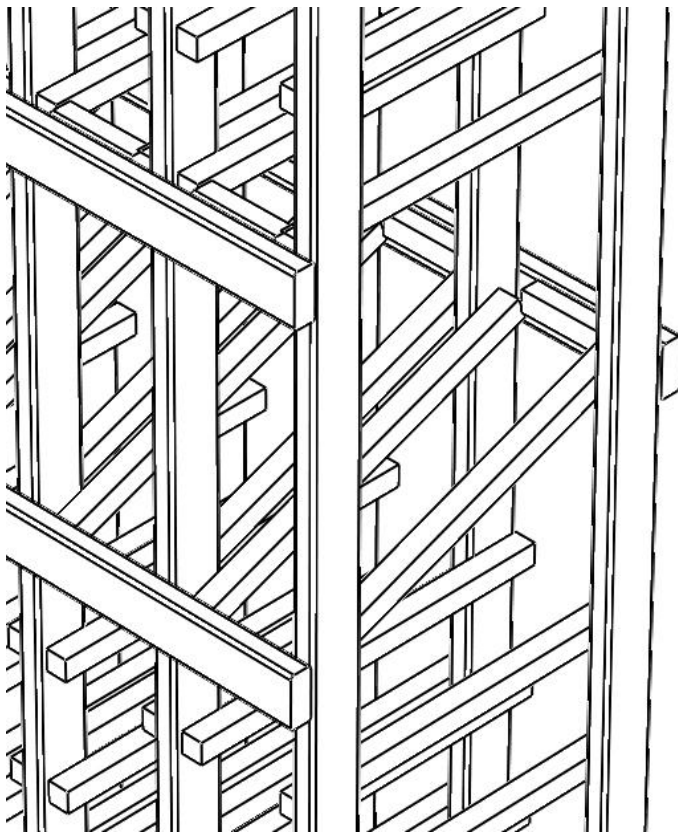
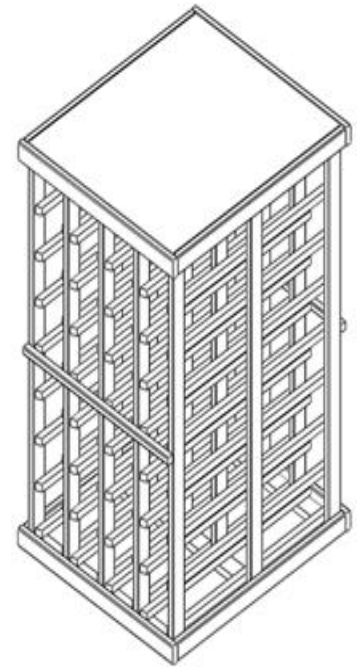

B.4 Display Rows for Wine Racks

Bottle Displays are a wonderful way to show your bottles. These are built nearly the same as regular racking with just a few differences. The main thing you want

to address is the front brace that is near the bottom of the bottle display. This can be either a normal front spacer or a wide front spacer like the one showing below. This spacer must be placed so that when the bottle is in the rack it



will be held from sliding forward.

In some designs a wide front brace is also used above the display. If one is included with your rack then place it in the location shown below.

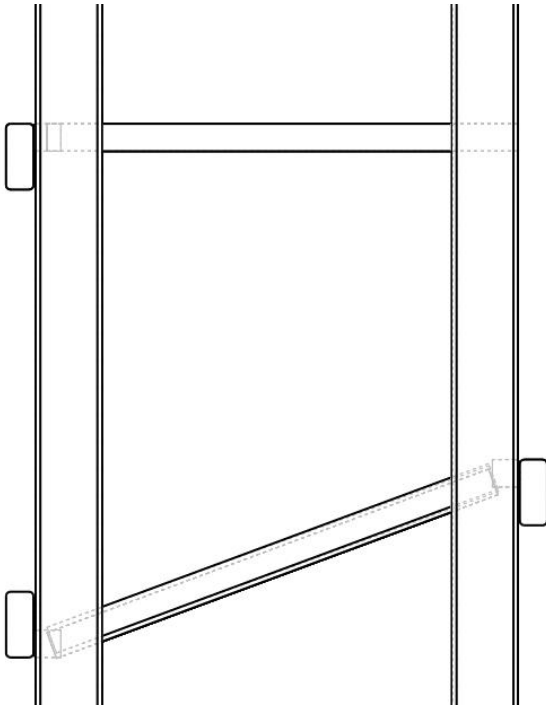

Step #1: Attach the top and bottom shelves to the ladders. Once the top and bottom shelves have been attached then you can proceed with the rest of the shelves.

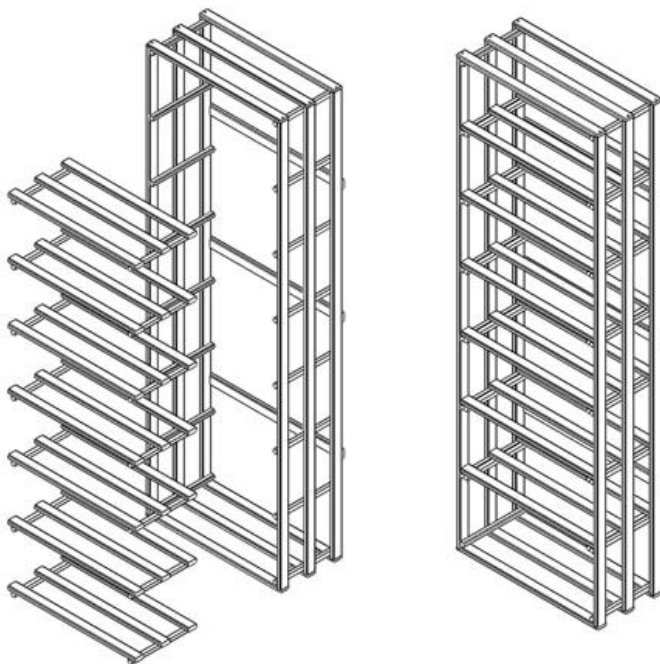

Step #2: Attach the back stabilizers to the rack.

Step #3: If your design includes top and bottom trim then this is the time to put them on.

NOTE: Even though this rack is designed to stand alone we recommend that you secure it to a wall to prevent accidental injuries. The Back Braces are an excellent way to firmly attach your rack to the wall.

Page 4 of 11

D. Diamond and X Bins

D.1 Lattice Diamond Bin

Step #1: Attach the top and bottom shelves between ladders.

Step #2: Attach the rest of the Horizontal racks.

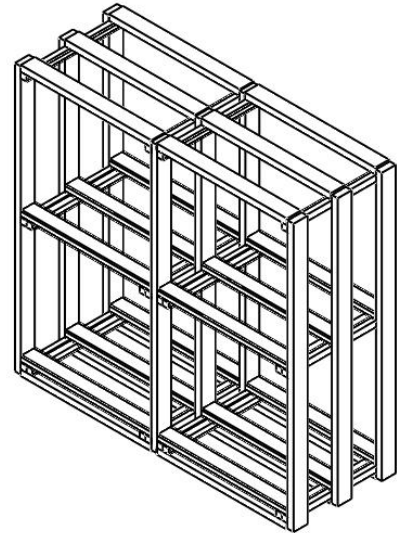
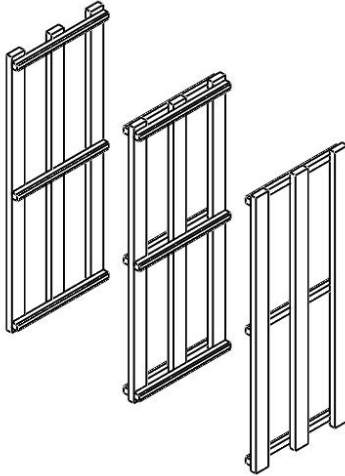

Step #3: Now Place the angled shelves into the rack. These can be placed in the traditional Diamond pattern or can be turned to create an X or other shapes.

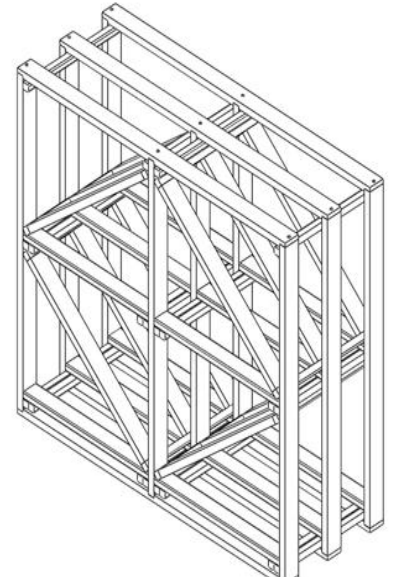
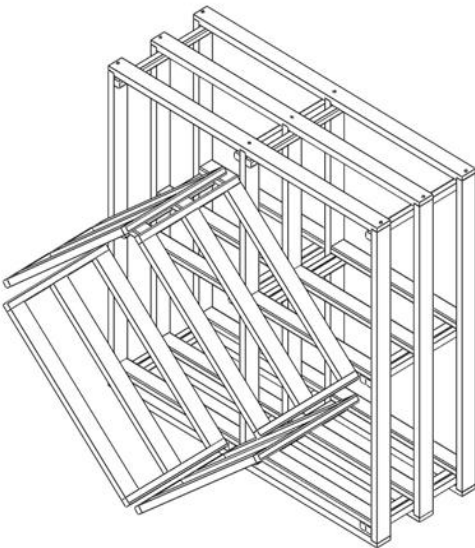

Step #4: Attach the top and bottom trim to the front and back of the rack. If you would like to attach it to the wall you may attach the back bracing to the wall at this time.

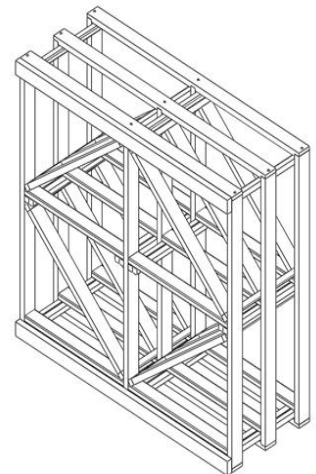
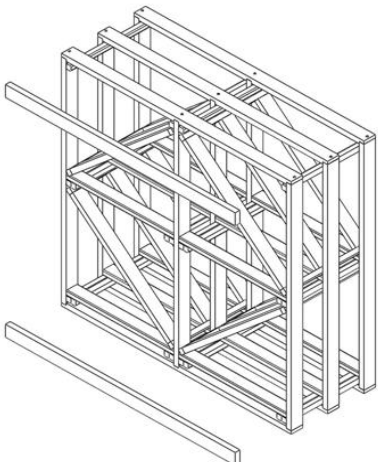

D.2 and D.3 X-Bin and Diamond Bin

Solid X-Bins and Diamond bins are usually shipped assembled. If your x-Bin/Diamond Bin is shipped disassembled then see direction below.

- 1) Start by attaching the top and bottom to the left and right side.
- 2) Interlock the shelves together and slide them into the rack. This image shows an X-Bin, Diamond bin will be the same but will have 4 more shelves.
- 3) Place Rack where you would like it and attach it to other racks if you feel it is necessary.

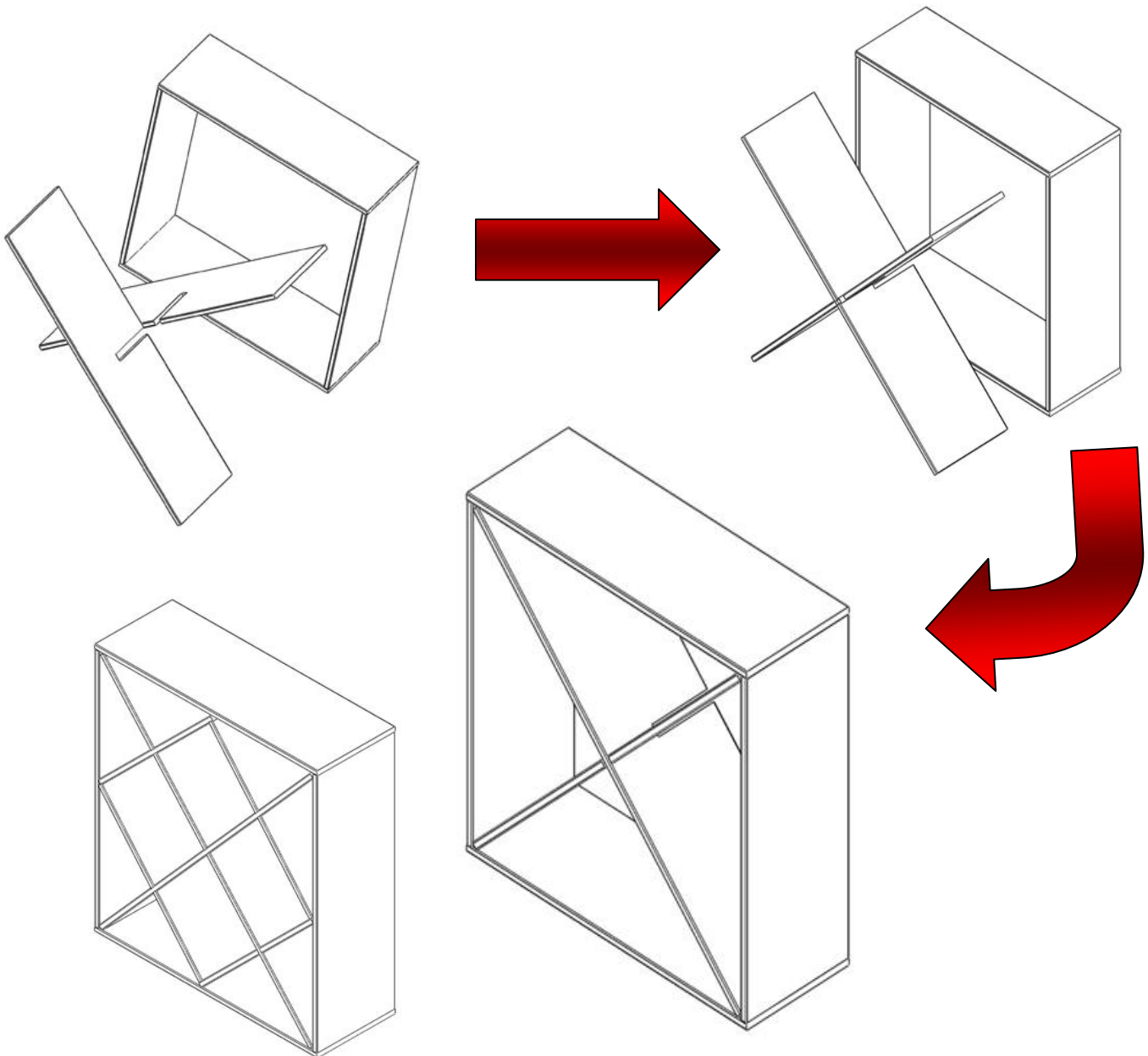

E. Decanter's

Decanters will usually ship assembled.

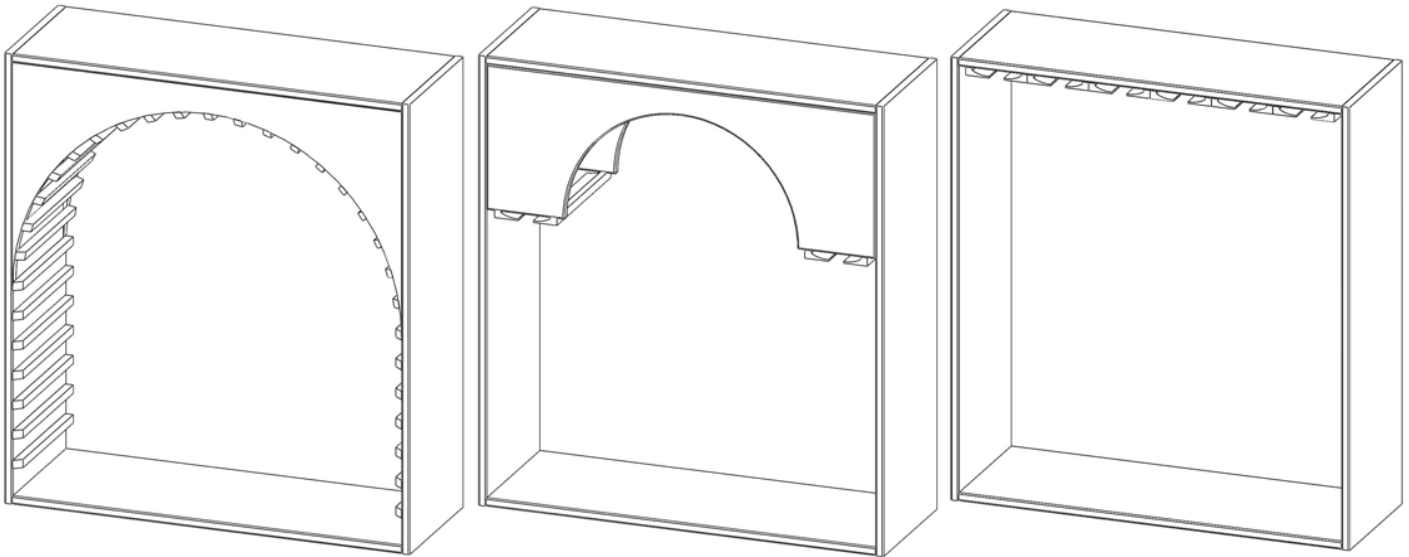

F. Drawers

Drawers are manufactured as a self contained unit and will not need assembly. Just place the drawer assembly on top of and underneath the racks it will go with (as seen below).

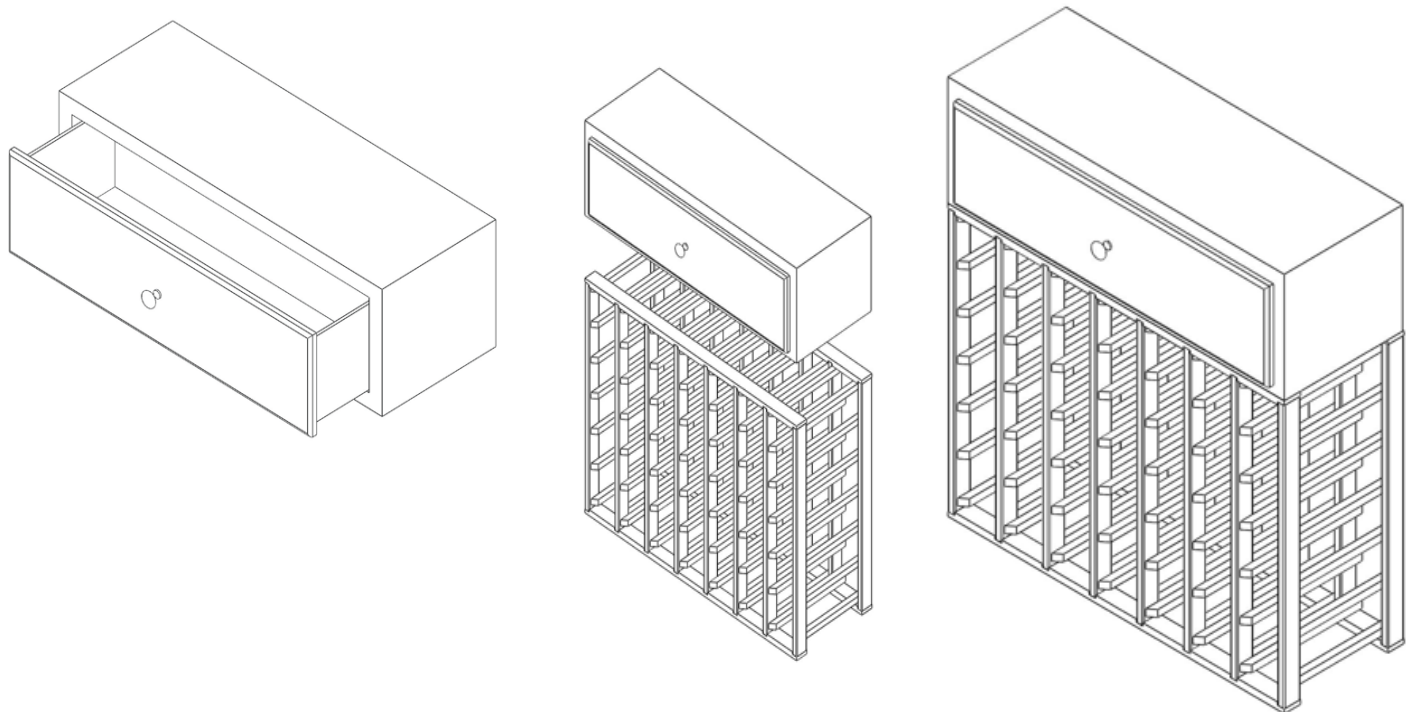

G. Quarter Round Wine Shelf

Quarter round wine shelves are usually shipped assembled but if they are sent unassembled then just attach all the vertical strips to the shelves using the provided screws.

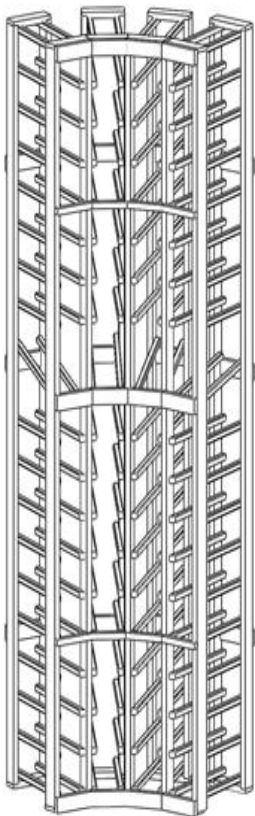
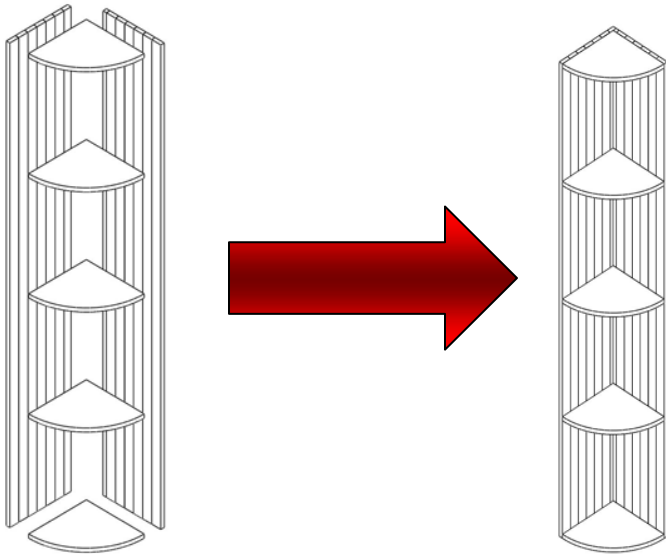

H. Curved Corners

Curved corners are shipped assembled.

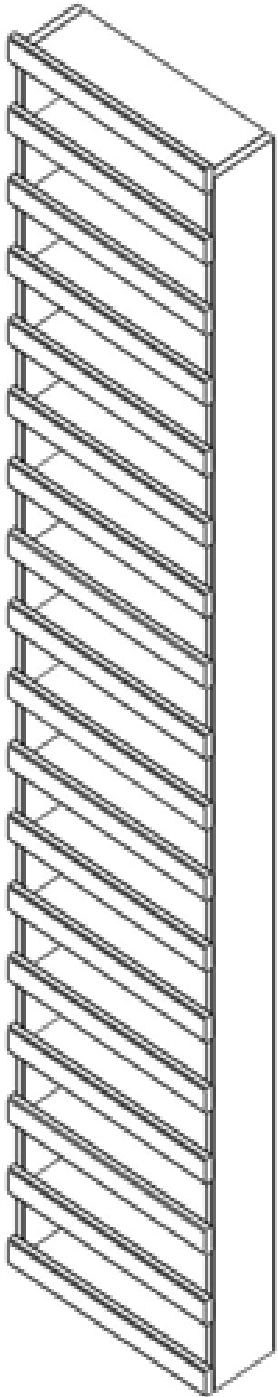

Solid Horizontal
Display Racking

I. Horizontal Display Racking

There are several different types of horizontal display racking. The solid wood horizontal displays are shipped assemble so you just need to attach them to the wall. For Lattice horizontal displays see assembly instruction on next page.

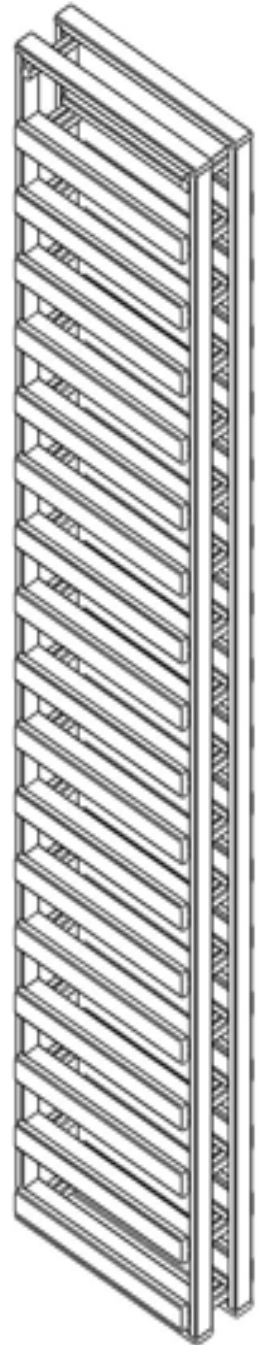

Lattice Horizontal
Display Racking



Assembly of Lattice Horizontal Display Rack

Step #1: Attach the top and bottom shelves to the ladders using the screws provided.

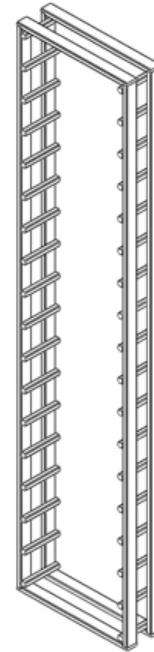

Step #2: Attach the remainder of the shelves to the ladders.

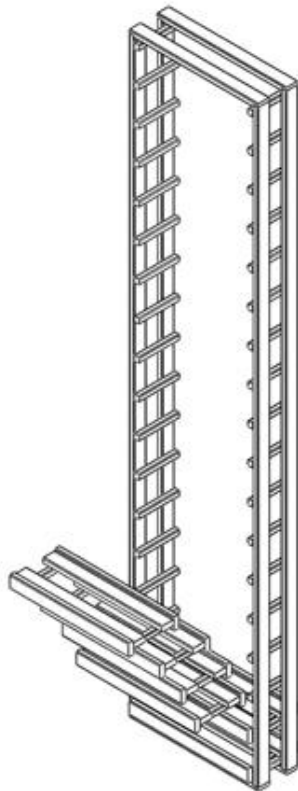

Step #3: Attached the back and any front bracing and spacers if included in design.

If you would like to attach it to the wall you may attach the back bracing to the wall at this time.

